

# Maintenance Instructions



**Testomat 2000<sup>®</sup>**  
**Testomat ECO<sup>®</sup>**



# Contents

<b>Contents</b> .....	<b>2</b>
<b>Important safety information</b> .....	<b>3</b>
Qualification of the staff .....	3
Warning notices in these instructions .....	3
Further documents.....	4
<b>General instructions</b> .....	<b>4</b>
Testomat 2000® in steam boiler plants with BOB operation: .....	5
Prior to carrying out maintenance work .....	6
Permissible tools .....	6
<b>Carrying out maintenance</b> .....	<b>7</b>
Cleaning the measuring chamber and the sight-glass windows.....	7
Cleaning the receiver optics.....	7
Cleaning the filter housing .....	8
Cleaning the housing .....	8
Removing and installing the measuring chamber holder.....	9
Re-adjusting the measuring chamber holder (Overflow detection) .....	9
Replacing the EPROM (software update).....	10
Opening the factory programming .....	10
Installing the interface cards SK910, UK910, RS910 (only Testomat 2000®) .....	11
Position and function of the fuses .....	12
Repairing or replacing the dosing pump .....	14
Checking dosing .....	15
<b>Special function “Adjust mode”</b> .....	<b>15</b>
Testing of the overflow detection .....	16
Checking the automatic adjustment.....	16
<b>Water consumption</b> .....	<b>17</b>
<b>Indicator consumption</b> .....	<b>17</b>
Indicator TH2025, TH2100, TH2250.....	18
Indicator TH2005 .....	18
<b>Manual measured value check</b> .....	<b>19</b>
<b>Troubleshooting</b> .....	<b>20</b>
Error message MST analysis.....	20
Switching on the real-time clock (only Testomat 2000®).....	22
Low water level .....	22
Error message FST optics (Testomat 2000®).....	23
Error message MST turbid.....	23
Error message Ff outlet to drain .....	23
Error due to defective hardware .....	23
Readjusting the current interface.....	24
<b>Spare parts lists</b> .....	<b>25</b>
<b>Component positions</b> .....	<b>26</b>
Check List Testomat 2000® .....	31



## Important safety information

- Please read the operating instructions and maintenance instructions carefully and completely prior to carrying out maintenance work at Testomat instruments.
- Observe the warning notices in these maintenance instructions and the operating instructions of the respective instrument.
- Always adhere to hazard warnings and safety tips when using reagents, chemicals and cleaning agents. Please adhere to the respective safety data sheet! Download the safety data sheets for the supplied reagents at <http://www.heyl.de>.

### Qualification of the staff

Maintenance work requires fundamental electrical and process engineering knowledge as well as knowledge of the respective technical terms. Assembly and commissioning should therefore only be carried out by a specialist or by an authorised individual supervised by a specialist.

A specialist is someone who due to his/her technical training, know-how and experience as well as knowledge of relevant regulations can assess assigned tasks, recognise potential hazards and ensure appropriate safety measures. A specialist should always adhere to the relevant technical regulations.

### Warning notices in these instructions

The warning notices in these instructions warn the user about potential dangers to individuals and property resulting from incorrect handling of the instrument. The warning notices are structured as follows:



#### SIGNAL WORD!

---

#### Description of the type or source of danger

Description of the consequences resulting from non-observance

- Preventive measures. Always adhere to these preventive measures.
- 



“**DANGER**” indicates an immediate hazardous situation which, if not avoided, will result in death or serious injury.



“**WARNING**” indicates a potentially hazardous situation which, if not avoided, could result in death or serious injury.

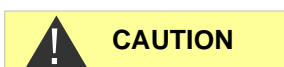

“**CAUTION**” indicates a potentially hazardous situation which, if not avoided, could result in minor or moderate injuries or property damage.



“**NOTE**” indicates important information. If this information is not observed, it may result in an undesirable result or state.

## Further documents

Testomat instruments are plant components. Therefore, always observe the documentation of the plant manufacturer.

## General instructions

Regular maintenance is necessary to ensure trouble-free operation of the Testomat instrument. Regular visual inspections also increase operational reliability. Also refer to the notes in the operating instructions!

### NOTE

#### Fix errors by yourself.

Experience has shown that many errors that occur in day-to-day operations you can fix by yourself.

This ensures that the instrument is soon working again. In this maintenance manual you will find possible causes of malfunctions and helpful hints for their elimination.

#### Overview of maintenance work to be executed

The maintenance intervals may vary depending on the water and pipeline quality.

Maintenance work	Quarterly	Semi-annually	Triquarterly	Annually	Biennially / Triennially	Page
Cleaning sight-glass windows	X	X	X	X		7
Measuring chamber Cleaning / Measuring chamber holder	X	X	X	X		7
Cleaning the receiver optics		X		X		7
Cleaning the controller/filter housing		X		X		8
Cleaning the waste water line	X	X	X	X		
Checking the dosing pump incl. suction and pressure hoses		X		X		15
Electrical and hydraulic connections		X		X		
Renewing the sealing kit (40124) and sight-glass windows				X		
Recommendation: Allow the manufacturer to overhaul the dosing pump					X	

### **Testomat 2000® in steam boiler plants with BOB operation:**

In accordance with the provisions of TRD 604, Sheet 1 (new WÜ 100), Testomat 2000® must be regularly maintained and, if necessary, inspected. Maintenance must be carried out every six months by the plant operator or an authorised service and maintenance provider. Please contact us if you require a regular maintenance service. We will then provide you with an offer.



Download of check list

- Clean the measuring chamber at regular intervals (approx. every 6 months) and, if possible, replace the two seals of the measuring chamber holder and the sight-glass windows.
- If the water has high iron content, cleaning might be necessary more often.
- Only use a dry, lint-free cloth for cleaning.
- To carry out maintenance work after the error message “Mf. soiling” or “Ff. optics”, always confirm the error message.
- Only Testomat 2000®: If maintenance is carried out after an instrument maintenance message (maintenance interval), maintenance must be confirmed. (In SERVICE I menu)
- Wait at least 5 seconds before switching the instrument on and then off again at the main switch.
- The repair of a defective instrument – irrespective of the warranty period - is only possible after the instrument has been dismantled and returned to us with a description of the error. Furthermore, please inform us of the indicator type being used and the measured medium. Before you return the instrument for repair work, remove the bottle and ensure that the measuring chamber has been flushed out and is empty. Prior to dismantling, always write down a description of the error (failure effect). For Testomat 2000® and Testomat ECO® please download the respective checklist from our website [www.hey1.de](http://www.hey1.de).
- Do not carry out any actions at the instrument which are not described in these instructions; failure to adhere to the instructions will negatively affect the warranty claims that you make thereafter.

## Prior to carrying out maintenance work

Carry out a visual inspection of the instrument:

- Are the instrument doors closed properly?
- Is the instrument heavily soiled?
- Is there air inside the dosing hoses?
- Are the hose connections of the dosing pump free of leaks?
- Has the use-by date of the indicator expired?

Always make sure that the sight-glass windows are clean before inserting a new indicator bottle.

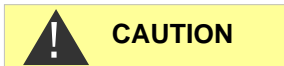

**CAUTION**

### Cleaning agents

- Never use organic solvents to clean the measuring chamber or other plastic parts!
- Use an acidic cleaning agent for cleaning.
- Please observe the safety regulations when handling cleaning agents!

## Permissible tools

Always use suitable tools for the described tasks. Refer to the table below for an overview of suitable tools, which can be purchased as tool kit T2000 (Art. no. 40138).



### Content of the tool kit T2000 (Art. no. 40138)

Size	Application	Art. no.
Torx, TX 20x100	Measuring chamber, snap-on installation	30991
Torx, TX 10x80	Measuring chamber holder	30992
Torx, TX 8x60	Display circuit board, measuring chamber holder	30993

## Carrying out maintenance

### Cleaning the measuring chamber and the sight-glass windows

Proceed as follows:



①

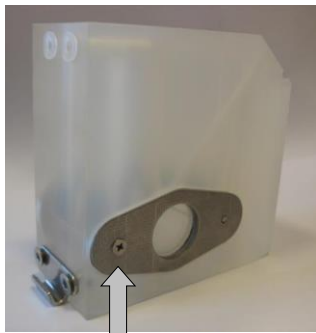

②

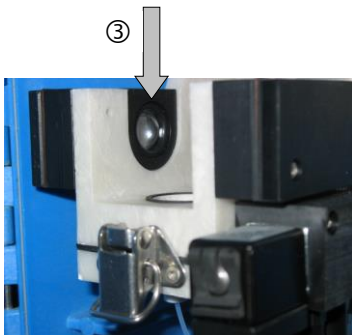

③

- Switch off the instrument or press the "STANDBY" key. If required, remove any water from the measuring chamber:

**M** → SERVICE I → MANUAL OPERATION → Drain chamber

- Close the manually-operated valve of the supply line to Testomat 2000®.
- Unhook the toggle type fastener ①, tilt the measuring chamber upwards and remove it.
- Release both sight-glass window holders ②, remove and clean the sight-glass windows.
- Use alcohol to clean off the film on the sight-glass windows. If the instrument has been used with hard water for a longer period of time (measuring range exceeded!), a hard-to-remove film may have formed on the sight-glass windows. In this case, clean the sight-glass windows as described below for cleaning the measuring chamber.
- The measuring chamber can be cleaned with a cleaning agent suitable for decalcification and rust removal. Flush the measuring chamber thoroughly after cleaning.
- After cleaning, re-insert the sight-glass windows and secure them using the sight-glass window holders b. (Do not forget the flat seals, making sure they are fitted correctly in the groove).
- Re-insert the measuring chamber and use the toggle type fastener to secure it.

### Cleaning the receiver optics

If you detect that the lenses of the receiver optics ③ (left-hand side of the measuring chamber holder) are soiled, please clean them using a dry, lint-free cloth.

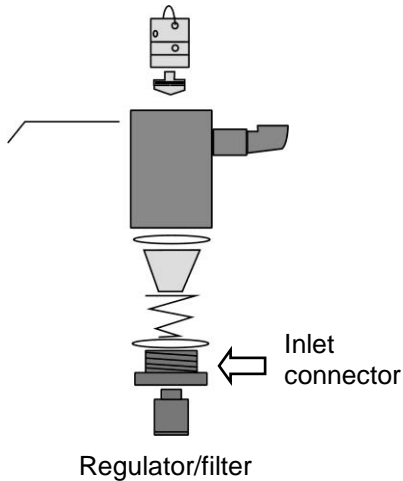

## Cleaning the filter housing

- Close the manually-operated valve of the supply line to Testomat 2000®.
- Depressurise the lines of Testomat 2000® via the function:
  - M** → SERVICE → MANUAL OPERATION → Flush chamber
- Switch off the instrument and loosen the hose connections at the filter housing.
- Unscrew the inlet connection using an open ended spanner (size 22).
- Remove the seal, spring and filter and clean them.
- Remove the retaining pin and extract the flow controller, subsequently remove the flow controller valve body.
- Clean the filter housing with water or alcohol; then reassemble the unit.
- If required, replace the seals.
- Insert the filter strainer with the cone facing downwards!
- Re-attach the hose connections at the filter housing.



**CAUTION**

### After assembly

- After assembly, make sure the connections are leak-free.
- Leaking water at sealed points can damage unit components.

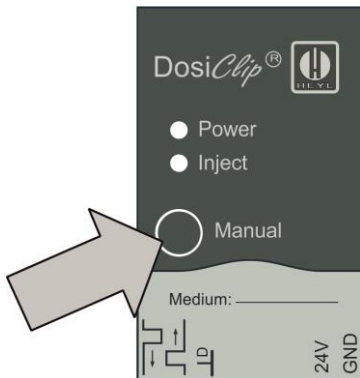

### How to check the unit for leaks:

- Switch the instrument to "STANDBY" **STANDBY**.
- Manually fill the measuring chamber:
  - M** → SERVICE → MANUAL OPERATION → Fill chamber
- Manually dose the indicator ("Manual" key).
- Check the connections and seals for leaks.
- Drain the measuring chamber.

## Cleaning the housing

The surface of the instrument housing is untreated. Therefore, avoid any soiling caused by indicators, oil or grease. However, if the housing becomes soiled, please clean the surface with alcohol (never use other solvents).



## Removing and installing the measuring chamber holder

(Required tool: Torx 10x80)

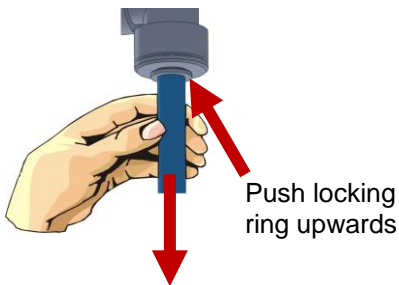
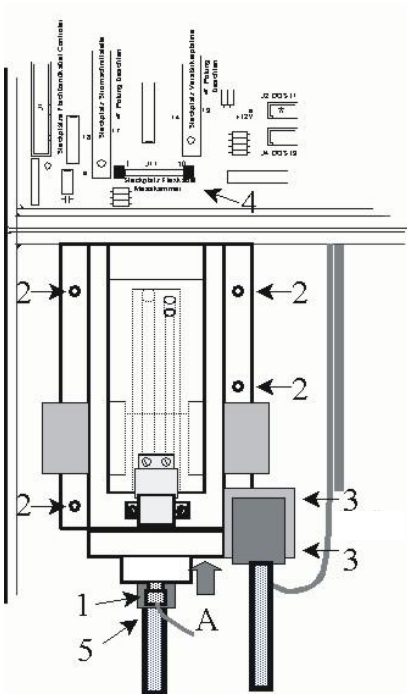

- Please stop the water supply to the instrument and drain the measuring chamber.
- Switch off the instrument.
- Unhook the toggle type fastener, tilt the measuring chamber upwards and remove it.
- Remove the stirring bar.
- Loosen the pressure hose (1).
- Loosen the four fastening screws of the measuring chamber holder (2).
- Loosen the valve block (3) from the measuring chamber holder (two fastening screws).
- Disconnect the plug from the flexible cable connection (4) on the base circuit board by pressing together and raising the two lateral levers. Unplug the flexible cable.
- Remove the measuring chamber holder from the front. To achieve this, remove the drain pipe (5) from the hose connection of the measuring chamber holder (see fig. push locking ring upwards).
- Install the new measuring chamber holder in reverse order.
- Ensure that the plug is locked into position after inserting the flexible cable connection.

## Re-adjusting the measuring chamber holder (Overflow detection)

(Required tool: Adjustment pin 2 mm, Art. no. 30990)

Testomat 2000® / ECO instruments have been factory set. Therefore, instrument adjustment during start-up is not required.

### NOTE

**All instruments from instrument number 222.899 and higher are equipped with a self-adjusting electronic circuit.**

- Adjustments are no longer required and no longer possible!

If the re-adjustment of instruments with a serial number below 222.899 is required after replacing the measuring chamber holder (error message "low water level" in spite of noticeable filling process), carry out the re-adjustment as follows:

- Switch off the instrument, press and hold the "DOWN" key and switch on the instrument again (Call the special function "Adjust mode").
- Use a suitable adjustment pin to turn the potentiometer on the base of the measuring chamber holder **A** (hole in the base) clockwise until the "Analysis" LED (overflow detection) illuminates.



- Subsequently turn the potentiometer anti-clockwise by an approx. 1/8 turn.
- Check correct functioning of the overflow detection circuit via the key **M** = input valve: The "Analysis" LED must illuminate while water is overflowing. Press key **M** again for quitting. The LED must extinguish once the overflow has finished.
- Back to normal operation: Press the "LEFT" and "DOWN" keys simultaneously.

---

### Checking water recognition

- Use the key **M** to check the water recognition function for instruments equipped with a self-adjusting electronic circuit.
- 

## Replacing the EPROM (software update)

(Required tool: Torx 8x60)



### Avoid static charges during installation/de-installation and observe the direction of installation!

Non-adherence can result in damage to or destruction of the electronic components on the circuit board or of the EPROM.

---



### New EPROM from device number 246 000

Note that from device number 246 000 onwards, a new EPROM module is used in the Testomat® ECO. Since the control board of the old module (NOVRAM - software 51 M XXX) does not fit the new module (FRAM – software 251 M XXX), the control board must always be replaced additionally.

---

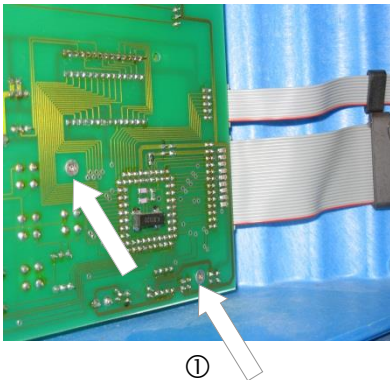

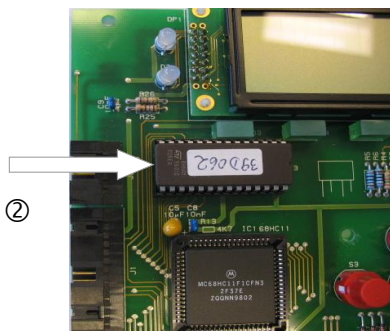

- Switch off the instrument.
- Loosen the six fastening screws ① of the display circuit board
- Carefully remove the EPROM ② from the socket (please make a note of the direction of the marking).
- Insert the new EPROM.
- Fasten the display circuit board.
- Switch on the instrument.



## Opening the factory programming

After replacing the EPROM, carry out basic programming.

- Switch on the instrument by simultaneously pressing the  and  keys. Your programmed settings are lost and the factory settings are reset (also see the operating instructions!).

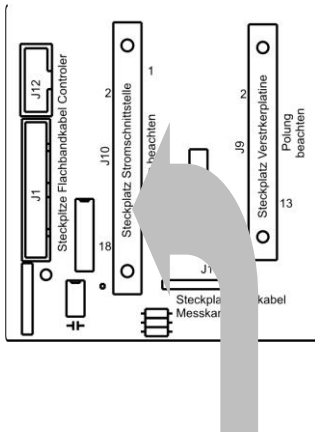

## Installing the interface cards SK910, UK910, RS910 (only Testomat 2000®)

- Switch off the instrument:
- Open the upper housing cover:
- Insert the plug-in circuit board into the left-hand slot with the component side on the left (contact no.1 is at the top).
- Switch on Testomat 2000®.
- Under menu item "BASIC PROGRAM → PROGRAM VALUES → INTERFACES" select either "type 0-20mA" or "type 4-20mA" for the cards SK910/UK910.  
Select "type RS232" for the interface card RS910.



Interface SK910



Voltage interface UK 910

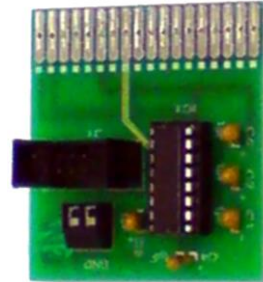

Interface RS910 (RS232)



### Avoid static charges during installation!

- Non-adherence can result in damage to or destruction of electronic components on the circuit board.

## Position and function of the fuses

Fuses  
Testomat 2000®

Description	Error during failure	Rate	Art. No.
<b>F1</b>	Instrument not functioning	T0,2A (115V)	31594
<b>F2</b>	Instrument not functioning	T0,1A (230V) T1A (24V)	31595 31592
<b>F4</b>	"Ff. 24V failure" dosing pump not functioning	T0,16A (230V) T0,315A (115V)	31622 31585
<b>F5</b>	Display failure	T0,315A	31585
<b>F6</b>	"Low water level", alarm relay active	T0,315A	31585
<b>F7</b>	Power output not functioning	T0,08A	31596
<b>F8</b>	"Ff. 24V failure" dosing pump not functioning	T1A	31592
<b>F9</b>	Instrument not functioning	GS-M 5x20V 4A	31582

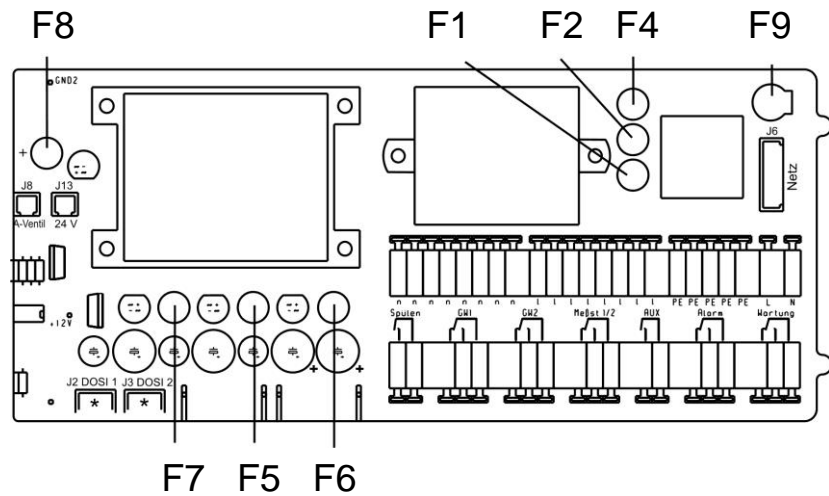

Fuses  
Testomat ECO®

Description	Error during failure	Rate	Art. No.
<b>F4</b>	Instrument not functioning	T0,16A (230V) T0,315A (115V)	31622 31585
<b>F8</b>	Instrument not functioning	T1A	31592
<b>F9</b>	Instrument not functioning	GS-M 5x20V 4A	31582

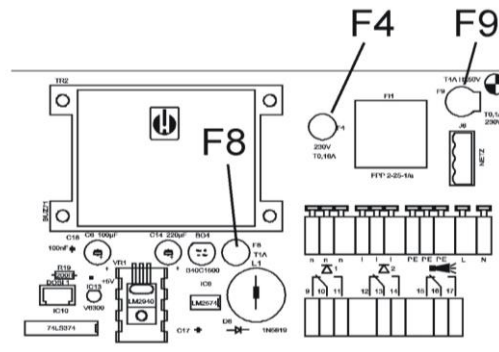

In case of overload or short circuiting at the relay outputs, fuse F9 is triggered (if the power for the external consumers is supplied from terminals "l" of "n").

## Repairing or replacing the dosing pump

### NOTE

#### Maintenance rate

The dosing pump DOSIClip® is a high-precision piston dosing pump, which makes up to 400 000 pump strokes per year depending on the settings (a measurement all 10 minutes x 4 pump strokes every day). To ensure proper operation for many years, we recommend sending in the pump for servicing **every 2-3 years**.



### CAUTION

#### Calibration on-site not possible!

We would like to point out that a repair of the dosing pump should be performed only marginally, because calibration of the dosing pump on-site is not possible.

We recommend exchanging a defective pump and sending it in for servicing to the factory.

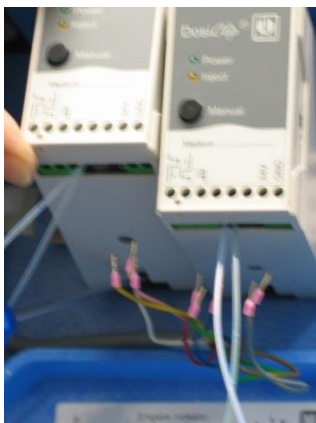

A pump which does not function properly results in incorrectly measured values (e.g. error message "Mf. Analysis"). If you have problems with the dosing pump, we recommend replacing it.

Proceed as follows to replace it:

1. Switch off the instrument.
2. Loosen the five cables of the terminal connections using a suitable screwdriver.
3. Loosen the hose connections at the indicator bottle and at the measuring chamber holder.
4. Collect the indicator in a container!
5. Use a screwdriver to push the lock of the pump housing downwards and remove the housing from the top
6. At first, place the replacement pump on top of the DIN rail and push the housing downwards until the lock engages
7. Reconnect the cables (observe the colour sequence!)
8. Reconnect the hose connections (note the suction and pressure side!)

## Checking dosing

When measuring the hardness, it is checked whether the yellow value is at least 50 below the limit value after each (except the first) dosing stroke. Each stroke usually results in the value being reduced by 80 to 100 digits.

- Manually activate the dosing pump once.
- In "Adjust mode", display the yellow value under "G:####".

### NOTE

It is essential that the stirrer is switched on during the checking procedure.

Checks can only be carried out with indicator type TH!

## Special function "Adjust mode"

The adjust mode is used for adjusting the overflow detection and testing the optical amplification setting.

### NOTE

The amplification setting is carried out in the normal measuring mode of the instrument, i.e. manual adjustment is not required. The test described below is only used for checking and error detection.

### Call of adjust mode

- Press and hold the "DOWN" (1) key and switch on the instrument.

### Back to measuring mode

- Press the "DOWN" (1) and "LEFT" (9) keys simultaneously.

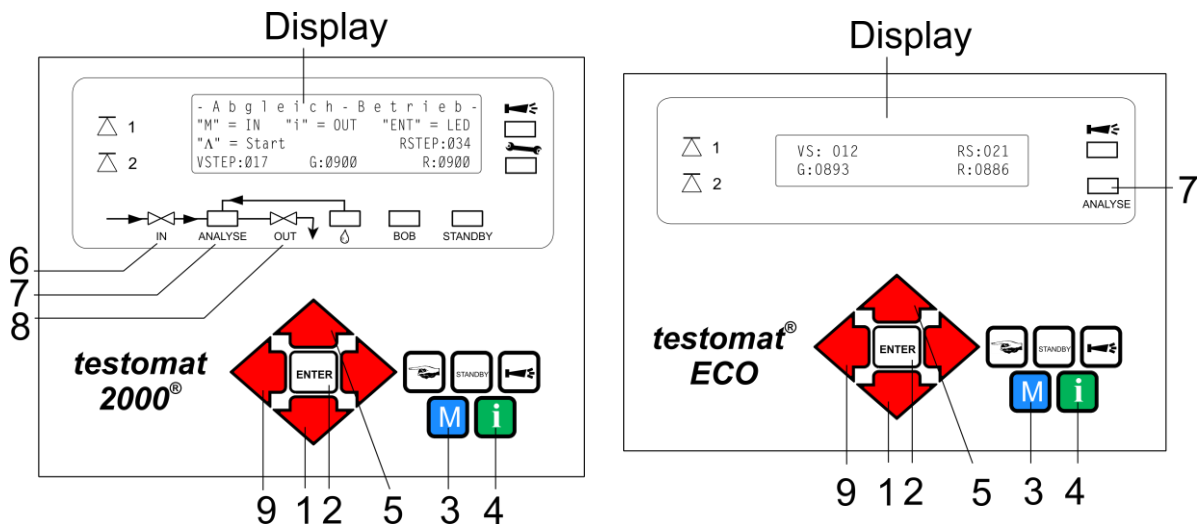

## Testing of the overflow detection

- Press the "M" (3) key to open the input valve IN.  
*Only Testomat 2000®: the "IN" LED (6) illuminates.*
- The "ANALYSIS" (7) LED must illuminate when the water flows through the overflow borehole of the measuring chamber (If this is not the case, adjust the overflow detection as described above).
- Press the "I" (4) key to open the output valve OUT.  
*Only Testomat 2000®: the "OUT" LED (8) illuminates.*

## Checking the automatic adjustment

- Prior to adjustment, fill the measuring chamber with water until overflow occurs.
- Switch to "Adjust mode" (see "Calling adjust mode").
- Press the "ENTER" (2) key to switch on the transmit diodes and the stirring mechanism.
- Press the "UP" (5) key to start automatic adjustment.
- Press the "Manual" button on the dosing pump.
- Read the values for yellow (Y:) and red (R:). Both values have to be 900 +/- 20.

If these values are not achieved, it may be due to the following reasons:

- The water is turbid.
- Air bubbles in the water.
- The measuring chamber is not filled correctly.
- The sight-glass windows are soiled or cracked.
- The receiver optics (lenses) is soiled.
- The plug connector of the flexible cable is not locked (loose contact).
- The measuring chamber holder is leaky, entered water has destroyed the electronics on the circuit board.
- Electronic component on the plug-in circuit board T2000-SE (Art. no. 40091) is defective.



## Water consumption

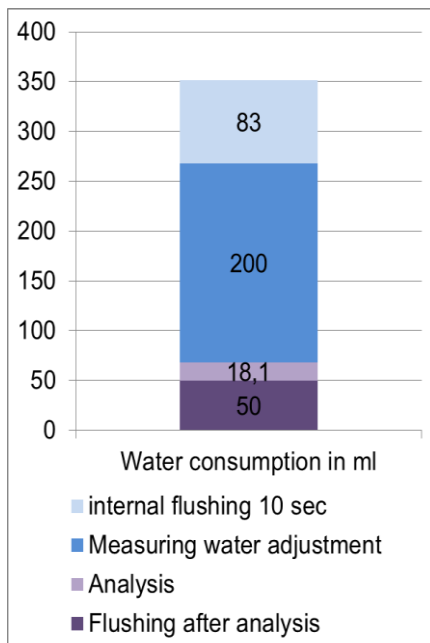

Water consumption of the instruments is composed of the analysis-relevant volume (18.1 ml per analysis), of the measuring water adjustment (150 – 200 ml per analysis), the water consumption for the internal flushing time 0.5 l (500 ml /minute). and the water consumption for flushing after analysis (approx. 50 ml).

- Flushing is carried out by simultaneously opening the inlet and outlet valve.
- The values for **measuring water adjustment** and **internal flushing** are variable and depend on the input water pressure.
- Water consumption for internal flushing with a programmed flushing time of 10 seconds is 83 ml. Shorter or longer flushing times influence the required volume of water in a linear fashion.

### Default setting:

Measuring water inlet pressure 2 bar = approx. 200 ml measuring water adjustment + 18.1 ml analysis volume = 218.1 ml / per analysis

**Example:** 10 sec. internal flushing time + analysis = total waste water quantity / per analysis

83 ml + 218.1 ml = 301.1 ml / per analysis

### NOTE

For connections longer than 3 m and with an internal hose diameter of 6 mm a minimum **internal flushing time** of 10 seconds is required to ensure that a valid sample is taken from the sampling line.

## Indicator consumption

Testomat functions via automatic titration. During the analysis process, the indicator is titrated drop-by-drop into the measuring chamber by the dosing pump until the colour changes. Please note that the applied indicators each provide a specific resolution.

**The greater the hardness of the water being analysed, the higher the indicator consumption!**

Moreover, indicator consumption is influenced by the frequency of analysis.

**Example:** Three strokes are dosed into the measuring chamber by the dosing pump at a hardness of 0.1 °dH. In this case, a 500 ml bottle of indicator is sufficient for 16 667 strokes. In other words, 5 555 analyses are possible. If an analysis is carried out every 30 minutes, for instance, the indicator bottle will last for approx. 2 777 hours. Resulting in an annual consumption of 3.15 bottles. Please remember that this calculation is an approximate value for indicator type TH 2005.

## Indicator TH2025, TH2100, TH2250

Number of analysis and range with 500 ml

### Range in hours

Water hardness (°dH)			Num. of Analysis	Interval (as a result of idle time and flush times/AUX) minutes							
TH2025	TH2100	TH2250		0	2	5	10	30	60	90	200
0,25	1,0	2,5	8333	278	556	972	1667	4444	8611	12778	28056
0,50	2,0	5,0	5556	185	370	648	1111	2963	5741	8519	18704
1,00	4,0	10,0	3333	111	222	389	667	1778	3444	5111	11222
1,50	6,0	15,0	2381	79	159	278	476	1270	2460	3651	8016
2,00	8,0	20,0	1852	62	123	216	370	988	1914	2840	6235
2,50	10,0	25,0	1515	51	101	177	303	808	1566	2323	5101

### Annual requirement indicator 500 ml (365d x 24h) 8760 hours/year

Water hardness (°dH)			Num. of Analysis	Interval (as a result of idle time and flush times/AUX) minutes							
TH2025	TH2100	TH2250		0	2	5	10	30	60	90	200
0,25	1,0	2,5	8333	32	16	9	5	2	1,0	0,7	0,3
0,50	2,0	5,0	5556	47	24	14	8	3	1,5	1,0	0,5
1,00	4,0	10,0	3333	79	39	23	13	5	2,5	1,7	0,8
1,50	6,0	15,0	2381	110	55	32	18	7	3,6	2,4	1,1
2,00	8,0	20,0	1852	142	71	41	24	9	4,6	3,1	1,4
2,50	10,0	25,0	1515	173	87	50	29	11	5,6	3,8	1,7

## Indicator TH2005

Number of analysis and range with 500 ml

### Range in hours

Water hardness (°dH)	Num. of Analysis	Interval (as a result of idle time and flush times/AUX) minutes							
		0	2	5	10	30	60	90	200
0,05	8333	278	556	972	1667	4444	8611	12778	28056
0,10	4167	139	278	486	833	2222	4306	6389	14028
0,20	2381	79	159	278	476	1270	2460	3651	8016
0,30	1667	56	111	194	333	889	1722	2556	5611
0,40	1282	43	85	150	256	684	1325	1966	4316
0,50	1111	37	74	130	222	593	1148	1704	3741

### Annual requirement indicator 500 ml (365d x 24h) 8760 hours/year

Water hardness (°dH)	Num. of Analysis	Interval (as a result of idle time and flush times/AUX) minutes							
		0	2	5	10	30	60	90	200
0,05	8333	32	16	9	5	2	1,0	0,7	0,3
0,10	4167	63	32	18	11	4	2,0	1,4	0,6
0,20	2381	110	55	32	18	7	3,6	2,4	1,1
0,30	1667	158	79	45	26	10	5,1	3,4	1,6
0,40	1282	205	102	59	34	13	6,6	4,5	2,0
0,50	1111	237	118	68	39	15	7,6	5,1	2,3

(All information without guarantee)

## Manual measured value check

The measured value check of the Testomat instruments is usually carried out during a laboratory analysis of the measuring water. In special cases, this check can also be carried out via direct input of a standard solution, created especially for this task, into the measuring chamber.

### NOTE

#### Creating a standard solution

- The standard solution must be created on-site for rapid application.
- For example, take a 1000 ppm solution and dilute it until you achieve the desired value in the upper third of the measuring range.

#### Manual supply of the standard solution

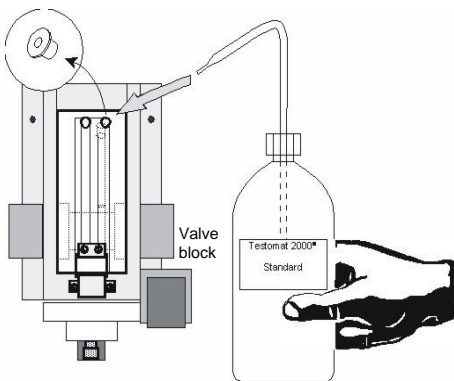

- Please stop the water supply to the instrument.
- Please remove the right-hand plug from the measuring chamber. The measuring chamber is manually filled with the standard solution via this borehole after starting the measurement. Common laboratory spray bottles can be used for this task.
- To start the check, activate the measurement via the  key.
- Testomat 2000® starts with an analysis cycle. If you have programmed a flushing time, do not fill the measuring chamber until the output valve has closed ("OUT" LED extinguishes).
- Fill the measuring chamber with the standard solution until it overflows. The input valve closes ("IN" LED extinguishes). This solution is then drained (flushing the measuring chamber).
- Once the output valve has closed ("OUT" LED extinguishes), refill the measuring chamber with the standard solution until it overflows. The filling level falls to the intended sample volume.
- The measured value is displayed once the analysis has finished.

# Troubleshooting

## Error message MST analysis

A measuring fault analysis occurs when the water in the measuring chamber is too “light” after the second dosing.

Check the following points if MST analysis is displayed:

### 1. The indicator's expiry date has been exceeded.

Remedy:

- There is insufficient dye in the indicator. Use a new indicator.
- When using an indicator that is not from Gebr. Heyl, replace it with the one recommended by us.

### 2. The stirring bar in the measuring chamber holder fails to rotate, resulting in an insufficiently mixed indicator.

Remedy:

- The stirring bar is stuck due to soiling in the stirring area of the measuring chamber holder. Clean the measuring chamber.
- The measuring chamber holder is leaky, entered water has destroyed the electronics on the circuit board. Change the measuring chamber holder.
- The plug connector of the flexible cable is not locked (loose contact). Insert the plug properly into the socket.
- The magnet in the stirring bar is too weak. Change the stirring bar.
- If necessary, insert a stirring bar.
- Check the plug contact of the flexible printed circuit board. If necessary, replace the measuring chamber holder.

### 3. The pump doses insufficient indicator.

Remedy:

- Check the dosing pump (see “Checking the dosing pump”). Contact your customer service representative or if necessary, replace the dosing pump.
- Check pump dosing (see “Checking dosing”). Contact your customer service representative or if necessary, replace the dosing pump.

### 4. Air is trapped in the indicator hose.

Remedy:

- Bleed the dosing hoses by pressing the “Manual” button on the dosing pump several times.
- Make sure that all the indicator hoses are fitted correctly. If not, air may enter the hoses!
- If the error re-occurs, replace the bottle insert for a screw cap with a suction tube (art. no.: 40135).
- Make sure that the suction and pressure hose set is not kinked or trapped. If necessary, replace the hoses. Complete suction hose (art. no. 40011), complete pressure hose (art. no. 40016).

**5. The water pressure is insufficient. Water is supplied, but the water level inside the measuring chamber remains too high after closing the inlet valve.**

Remedy:

- The water level should be approx. 32 mm above the lower edge of the transparent measuring chamber block.
- Make sure that the water pressure is within the valid range of 0.3 - 1 bar (without valve body) and 1 - 8 bar (with valve body).
- Make sure all the dummy plugs are in place at the measuring chamber (e.g. after maintenance). Make sure all the dummy plugs are fitted correctly, thus preventing air leaks.

**6. The drain pipe is blocked. Water may collect and stand in the pipe.**

Remedy:

- Make sure the water outlet is not blocked. If necessary, clean it.

**7. The measuring chamber is soiled.**

Remedy:

- All the channels in the measuring chamber and the measuring chamber sight-glass windows must be free of indicator residue or any other type of contamination.  
Dirt can be removed with either ethyl alcohol or another commercially available plastic cleaner.
- Also clean the receiver optics.

**8. The measuring water must be completely free of bubbles when carrying out measurements and should not have a milky appearance.**

Remedy:

- Make sure there are neither air bubbles nor more than 20 mg/l CO<sub>2</sub> in the measuring water.  
Air bubbles or milky measuring water may be the result of incorrect regeneration of the softening plant or residual salt in the soft water. Contact your customer service representative or use our aerator R (art. no. 130010).

**9. Iron (< 0.5 mg/l), copper and aluminium ions (<0.1 mg/l) may impair the measurement.**

Remedy:

- This is probably caused by old iron pipes, new copper pipes or changes to the well water. Pay attention to the composition of the measuring water.  
Contact your customer service representative or use our colourimetric test kits for iron (art. no. 410547) and copper (art. no. 410562) when carrying out checks.

## 10. Fuse failure for measuring amplification

Remedy:

- Check the F5, F6, F7 fuses and, if necessary, replace it.

## 11. Measuring chamber was not correctly filled.

Remedy:

- Check if the closing plugs in the measuring chamber fit tightly. Pay special attention to the rear plug. If it doesn't fit, air is sucked through and the measuring chamber cannot siphon correctly. This leads to low water in the measuring chamber or overflowing.
- Replace old or missing closing plugs with new (Maintenance lab Art. No. 270335). If you don't have these on hand, use a tape to help, until you've got the spare part.
- Check the inlet solenoid valve. Excessive or insufficient water in the measuring chamber indicates incorrect opening/closing of the solenoid valve. ( foreign particles / wear )  
Indicator and water quantity must be correct. Otherwise it will result in incorrect measurements.

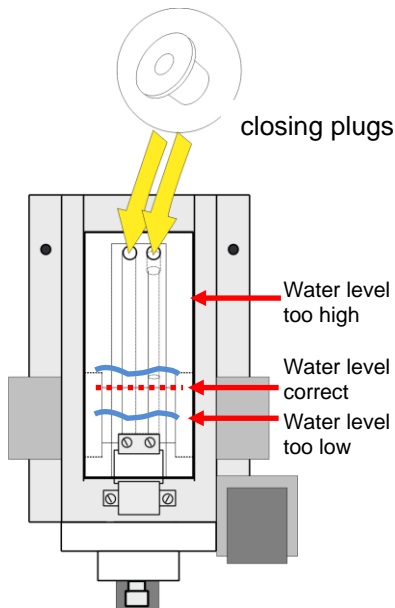

## Switching on the real-time clock (only Testomat 2000®)

If the integrated clock no longer works (e.g. due to EMC faults), you can restart it.

- Switch off the instrument,
- Press and hold the "ENTER" key
- Switch on the instrument again.

## Low water level

Remedy:

- Check the inlet water (filter strainer, etc.) for foreign particles. If necessary, clean the filter strainer.
- There is no inlet water even though the IN lamp is lit. Check the inlet water connection.
- The inlet pressure is too low (less than 1 bar). Remove the pressure valve body (see "Cleaning the controller/filter housing").
- Typically 400 ml/min must flow through the measuring chamber to flush and fill the measuring chamber.
- The inlet solenoid valve is defective. Check the F8 fuse and the plug contact at the inlet valve.
- Overflow detection does not react. Check the overflow detection (see "Special function Adjust mode").

## Error message FST optics (Testomat 2000®)

### Remedy

- The plug-in circuit board driver/receiver SE-T2000 (art. no. 40091) is defective. Replace the plug-in circuit board.
- There is an error at the optical component. The receiver is defective. Replace the measuring chamber holder.
- Cold water (<8°C) combined with a warm and humid ambient temperature (>28-30°C) can lead to the formation of water drops on the sight-glass windows.

## Error message MST turbid

### Remedy:

- Check whether the supplied measuring water is very turbid or soiled.
- Check whether the sight-glass windows are soiled and, if necessary, clean them.
- If necessary, install a filter (art. no. 11217) in the inlet of the instrument.
- Cold water (<8°C) combined with a warm and humid ambient temperature (>28-30°C) can lead to the formation of water drops on the sight-glass windows.

## Error message Ff outlet to drain

Water remains in the measuring chamber although LED "OUT" illuminates.

### Remedy:

- Check whether the outlet valve is soiled or if the connector at the outlet valve is oxidised. If this fails to eliminate the error, replace the valve.

## Error due to defective hardware

### 1. The dosing pump runs permanently.

#### Remedy:

- Check whether the broadband cable at the main and front board is loose or defective.

### 2. The inlet valve allows water to flow through it.

#### Remedy:

- Check whether the inlet valve is soiled.

### 3. The outlet valve allows water to flow through it.

#### Remedy:

- Check whether the outlet valve is soiled. Is there a permanent voltage on the valve?  
This would be the result of a software or hardware error. Carry out a reset (see operating instructions).  
If this fails to eliminate the error, replace the valve.

## **Readjusting the current interface**

**A signal of less than 20mA is output at the current interface.**

Remedy:

- Contact your customer service representative.



## Spare parts lists

Articles marked with an \* can only be used for Testomat 2000® and articles marked with an \*\* can only be used for Testomat 2000 ECO®. Unmarked components can be used for both instruments.

Art. no	Pressure controller
40125	Controller/Filter receiver, complete
40127	** Controller/Filter receiver with hose
40120	Controller/Filter receiver
40129	Controller plug T2000, complete
11225	Flow controller valve body, complete
11230	Retaining pin for controller plug
11217	Inlet filter
11218	Spring for inlet filter 19.5dx25
40121	Inlet connector
11216	O-ring 20x2
40153	Plug-in connector - G 1/4" -6
40157	Angled plug-in connector G 1/8"
Measuring chamber	
40173	Sight-glass window 30 x 3 with seal
40170	Sight-glass window 30 x 3
40176	Sight-glass holder, countersink and thread
33253	Bolt M3x40, A2, DIN 965
40032	Latch fastener TL-17-201-52
11210	Plug for measuring chamber T2000/Eco
40022	Measuring chamber T2000, complete
Measuring chamber holder	
40029	Measuring chamber holder, complete ET
40050	Magnetic stirrer, processed
40156	Plug-in connector 3/8" -10, processed
40018	* Solenoid valve, 2/2-way
40056	** Solenoid valve, 2/2-way
40181	Rear guide bar for measuring chamber 5x60
Dosing pump DOSIClip®	
40001	Jet pump, complete
40011	Suction hose, complete
40016	Pressure hose, complete
40040	Valve set
32046	Plastic cover CNH 45 N
Bottle connection / Suction device	
40131	Screw cap with bottle insert T2000
40130	Screw cap GL32 - hole
40135	Bottle insert for screw cap with push-fit suction tube

Art. no	Unit spare parts list	
40294	* Base circuit board T2000, complete 230V	
37245	** Base circuit board T-ECO complete 230V	
40092	* Control circuit board T2000, complete	
40192	** Control circuit board T-ECO, complete	
40091	Plug-in circuit board driver/receiver SE-T2000	
40190	Cable sleeve 5-7, grey	
40191	Cable sleeve 7-10, grey	
31713	Ribbon cable 10 pole with EMI filter clamp	
40096	Ribbon cable 26 pole with EMI filter clamp	
40060	Cable loom 2V, complete, for T2000	
40062	Cable loom 2P, complete, for T2000	
40200	Cable loom, complete with power switch and cover	
31582	Fuse M 4 A, GS-M, 5x20	
31596	* Fuse for solder base T0,08A	
31585	* Fuse for solder base T0,315A	
31622	Fuse for solder base T0,16A	
31595	* Fuse for solder base T0, 1A	
31592	Fuse for solder base T1,0A	
Spare parts requirement for 2 - 3 years of operation		
40173	Sight-glass window 30 x 3 with seal	2 x
11217	Inlet filter	1 x
40124	Gasket set T2000 (according to maintenance requirements)	X*
31585	Fuse for solder base T0, 315A	1
31592	Fuse for solder base T1, 0A	1

Accessories		
040123	Retrofit kit for water inlet	
270337	Maintenance lab T2000/ECO	
040138	Tool kit T2000/ECO	
270305	* Interface card (0/4-20 mA)	SK 910
270315	* Interface card (0/2-10 V)	UK 910
270310	Interface card (RS232)	RS910

\* Testomat 2000®

\*\* Testomat ECO®

# Component positions

(Fig.: Testomat 2000®)

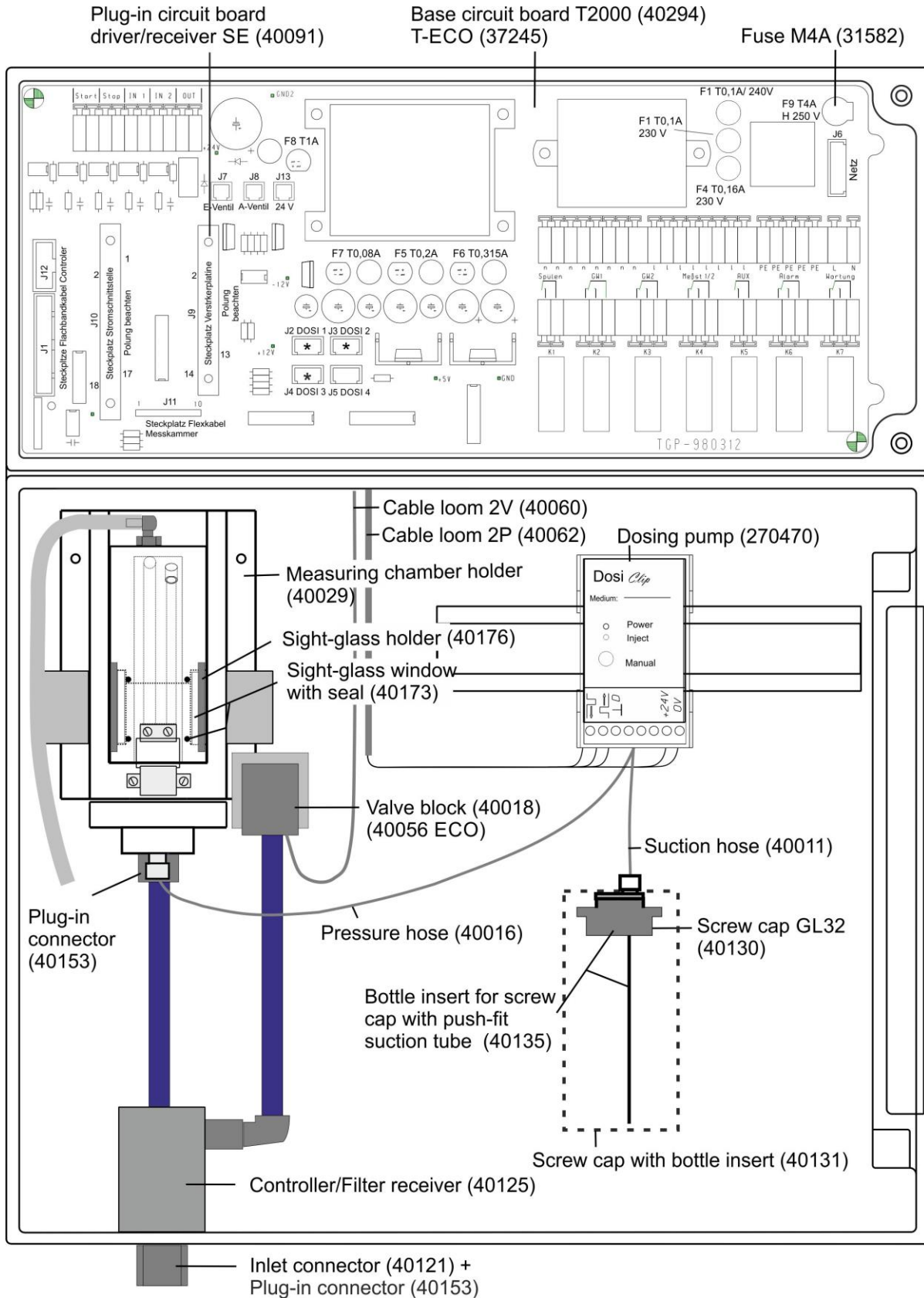

**Controller/filter receiver, with tube**

Item no.	Name	Article number	Quantity
1	Controller / filter receiver	40120	1
2	Controller plug	40129	1
3	O-ring	11249	2
5	Flow controller valve body,	11225	1
7	Locking pin	11270	1
8	Angled plug-in connector	40157	1
9	Inlet filter	11217	1
10	Spring for inlet filter	11218	1
11	Flat seal 24x2	33777	1
12	Inlet connector	40121	1
13	O-ring 20x2	11216	1
14	Plug-in connector	40153	1
15	Pipe OD 6x105	37754	1
16	Plug-in connector	40150	1

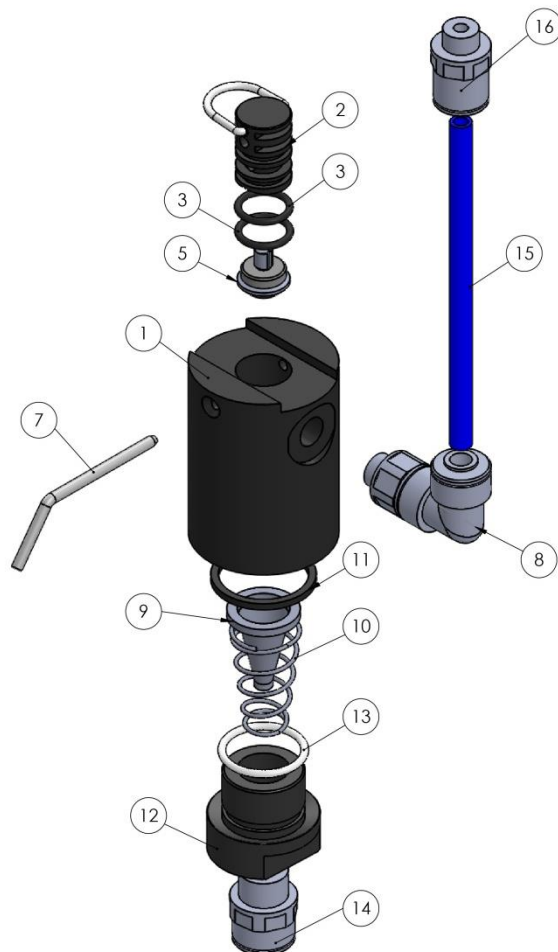

## Drainage and piping

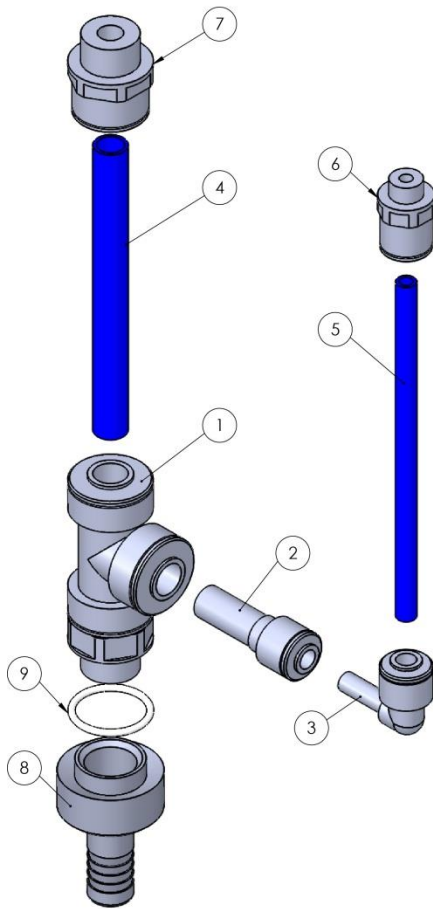

Item no.	Name	Article number	Quantity
1	T plug-in connector G3/8" – 10	40151	1
2	Reducing connector 10-6	40152	1
3	Plug-in angular connector 6-6	40154	1
4	Pipe 10x98	40240	1
5	Pipe 6x115	40142	1
6	Plug-in connector G1/8" - 6	40150	1
7	Plug-in connector G3/8" – 10	40156	1
8	Drainage connection	40122	1
9	O-ring 20x2	11216	1

## Content of the gasket set T2000 (Art. no.: 40124)

Number, size	Position	Art. No.
1 x O-ring 18x2	Measuring chamber holder	33776
1 x O-ring 4.47x1.78	Valve block	33775
4 x flat seal 24x2	Pressure controller, measuring chamber and measuring chamber holder	33777
1 x O-ring 20x2	Inlet screw connection	11216
2 x O-ring 10.82x1.78	Controller plug	11249

**Measuring chamber complete (40022)**

Item no.	Name	Article number	Quantity
1	Measuring chamber housing	37810	1
2	Flat seal 24x2	33777	2
3	Sight-glass window 30x3	40170	2
4	Sight-glass holder,	40176	2
5	Bolt M3x40	33253	2
6	Plug for measuring chamber	11210	3
7	Angled plug-in connector	40320	1
8	Tube, PVC, 3,0/1,5, 200mm	35852	1
9	Latch fastener	40032	1
10	Bolt M4x8	33252	2

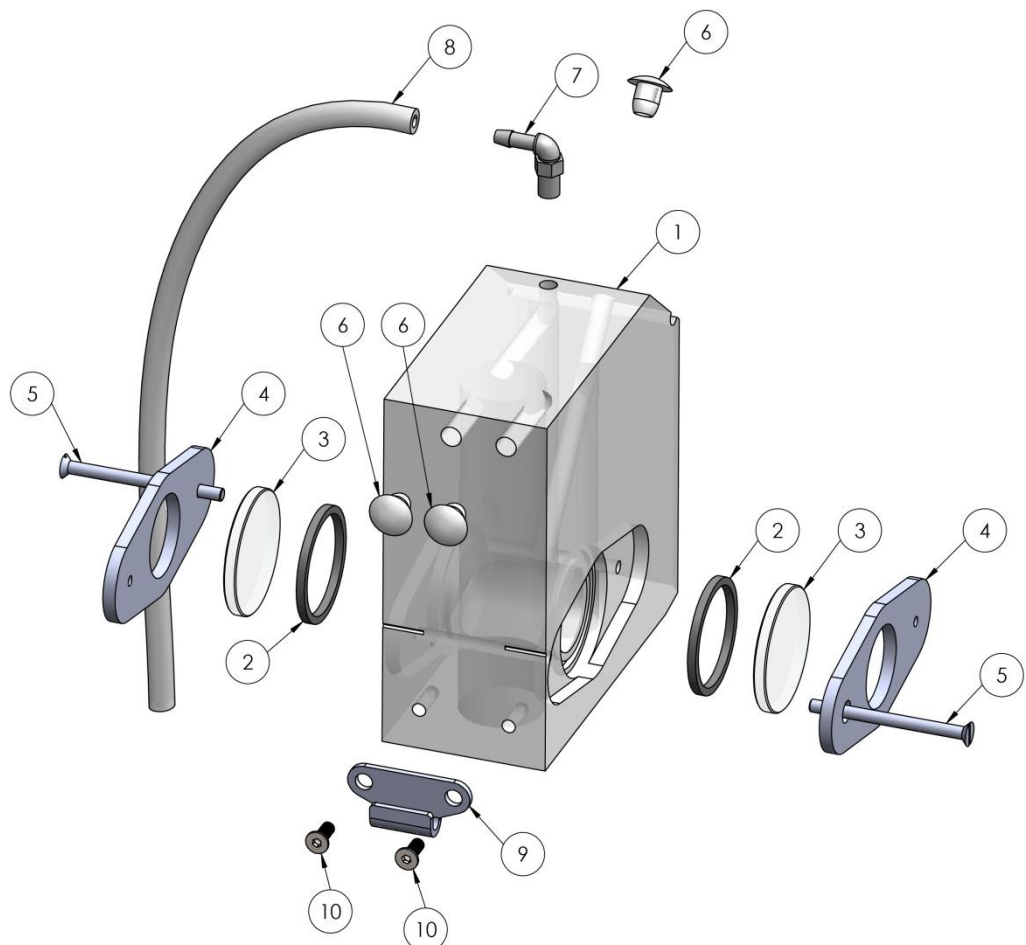

### Measuring chamber with double glazing (37812)

Item no.	Name	Article number	Quantity
1	Measuring chamber T2000 double glazing	37810	1
2	Flat seal 24x2	33777	2
3	Sight-glass window 30x1,6	37833	4
4	Seal 30x20x1,5	37808	2
5	Sight-glass holder 1,5 mm	37806	2
6	Bolt M3x40	33253	2
7	Latch fastener	40032	1
8	Plug for measuring chamber	11210	3
9	Bolt M4x8	33252	2
10	Angled plug-in connector	40320	1
11	Tube, PVC, 3,0/1,5, 200mm	35852	1

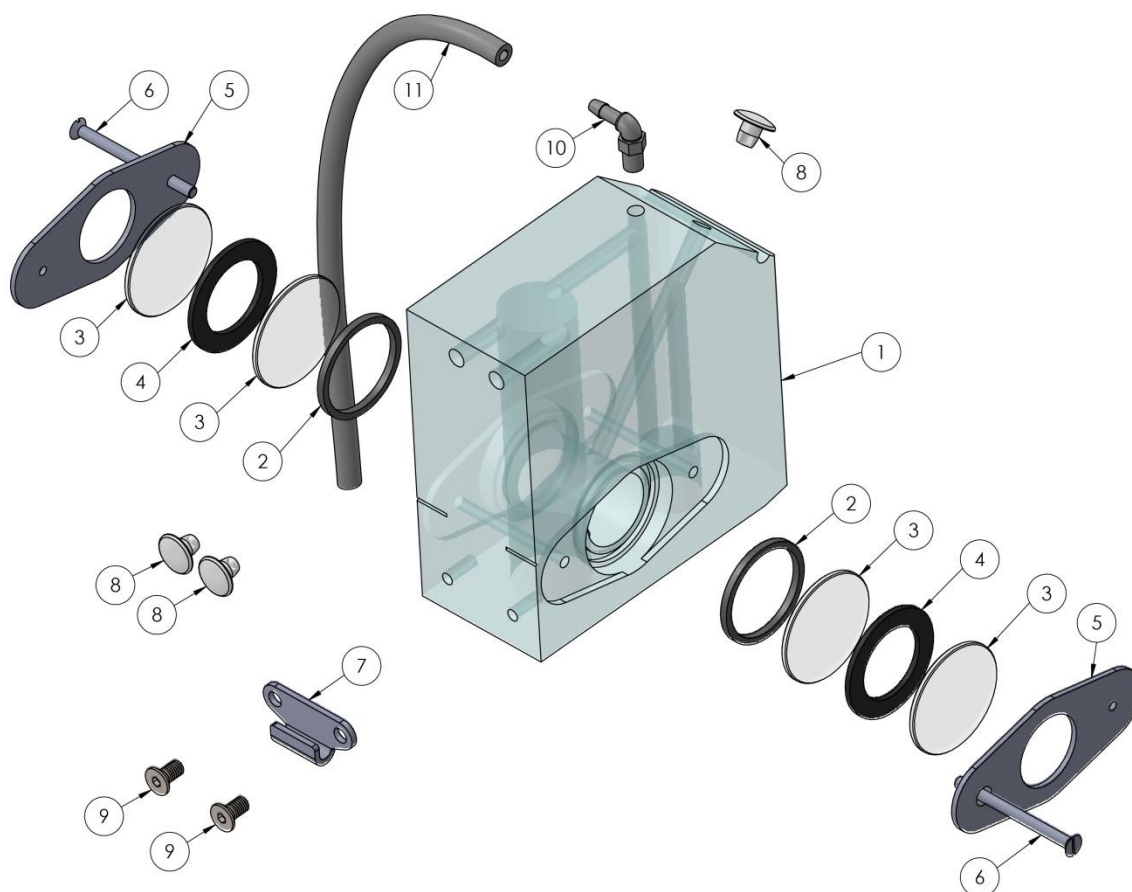

# Check List Testomat 2000®

Dear customers and service technicians,

This check list cannot replace your expertise or extensive experience in fault resolution. It is intended to support fast and systematic error diagnosis and error documentation. This list does not claim to be complete. We are therefore always grateful for any advice and information you may be able to provide. General user instructions can be found on the rear of this check list.

The Instrument Manufacturer

## Block 1 / Plant and instrument data

		Testomat 2000®				
		Testomat® ECO				
Plant type		Instrument type	Instrument no.	Indicator type	Software status	Pump no.

## Block 2 / Error message and error history

Please mark appropriately (X)

What does your instrument's error history display? ("i" and "Enter" key => operating instructions)				( Error history text )
Does an error message appear on the display? For example, "Mf. analysis", "Low water level", etc. (See operating instructions: "Error messages / Troubleshooting")	Yes	No		( Error message text )

## Block 3 / Visual inspection and functional test

Please mark appropriately (X)

If applicable, values / comments

Is the instrument connected to the mains voltage specified on the rating plate?	Yes	No	
Does a message appear on the display?	Yes	No	
Does the instrument display a plausible measured value? (possible manual measurement _____ value)	Yes	No	Measured value:
Are the measuring chamber and sight-glass windows clean?	Yes	No	
Are the measuring chamber and the water-carrying hoses free of leaks?	Yes	No	
Is the indicator's expiry date still valid? (See expiry date printed on the indicator bottle)	Yes	No	Expiry date:
Has the correct indicator type been programmed? (TH 2025 => 0.25 to 2.5 °dH = factory setting)	Yes	No	Type:
Is the water pressure within the specified range (400 ml/min)? (See the type plate on the instrument)	Yes	No	Plant pressure:
Does the drain hose prevent the risk of backwater? (No "syphoning effect"!!)	Yes	No	
Is the drain hose free of blockages? (Microorganisms caused by contamination, etc.)	Yes	No	
Does the set flushing time/quantity of flush water ensure that only freshwater is measured?	Yes	No	Flushing time:
Are the hoses at the dosing pump free from air bubbles? (Operate the pump manually / Carry out a manual analysis)	Yes	No	

### CARRYING OUT A (MANUAL) ANALYSIS

Does the water column rise evenly up to the overflow borehole when filling the measuring chamber (5 mm below the upper edge of the measuring chamber)? (If not: check the water pressure, water throughput/flow controller)	Yes	No	
Does the indicator pump dose correctly when starting an analysis? (LED at the pump illuminates!)	Yes	No	No. of dosing strokes:
Have the indicator and water been mixed properly in the measuring chamber after the dosing process? Check the magnetic stirring bar! =>see maintenance manual "Adjust mode"	Yes	No	

### PROGRAMMING DATA / OPERATING CONDITIONS

Have the limit values been set correctly? (Within the measuring range/according to the performance limit of the plant?)	Yes	No	Limit values:
Is the Testomat instrument always supplied with mains voltage – except during maintenance work/emergency situations? (Temporary shutdown only via the "Standby" key or the "Stop" input!)	Yes	No	See the "General instructions for operating Testomat 2000® and Testomat® ECO"

Please refer to "Error messages / Troubleshooting" in the **operating instructions** for further information on error messages and possible causes of faults.

Further functional tests (e.g. overflow detection and amplification setting => "Special function Adjust mode") and service instructions can be found in the **maintenance manual**.

After completing these checks, experience shows that it can be assumed that the checked functions (Block 3) are in effective working order if you have answered all the questions with "Yes". We recommend you to carry out these checks during each inspection or if faults occur.

# Instrument settings

## Caution!

Your settings may be deleted if repairs are carried out. Therefore, note down your instrument settings in the table below before sending the instrument to our service team for repairs. Please enclose a copy of the table with the instrument. If you have noted down the settings, they can be easily re-entered by your service staff once any repairs have been completed.

Menu	Setting
<b>MODE OF OPERATION</b>	
Time-controlled	
Volume interval	
Dynamics	
External (Start)	
<b>DISPLAY UNIT</b>	
Display in °dH	
Display in °f	
Display in ppm CaCO <sub>3</sub>	
Display in mmol/l	
<b>TYPE OF REAGENT</b>	
500ml-bottle	
100ml-bottle	
TH2005 Water hard.	
TH2025 Water hard.	
TH2100 Water hard.	
TH2250 Water hard.	
TC2050 Carbon. hardn.	
TC2100 Carbon. hardn.	
TM2005 minus-m-value	
TP2100 p-value	
<b>LIMIT VALUES</b>	
Limit val. 1:	
Limit val. 2:	
<b>FLUSH TIMES/INTERVAL</b>	
Internal flush time	
External flush time	
Interval pause	
<b>MEASURING POINTS</b>	
1 Measuring point	
2 Measuring points	
<b>TYPE OF WATER METER</b>	
1 Litre/Impulse	
2,5 Litres/Impulse	
5 Litres/Impulse	
10 Litres/Impulse	
100 Litres/Impulse	
500 Litres/Impulse	
1000 Litres/Impulse	
<b>LOCK OUT</b>	
Off	
Limit val. 1:	
Limit val. 2:	
<b>PLANT CONTROL</b>	
Min. Res. Quant.	
Limit val. 1:	
Limit val. 2:	
<b>BOB-OPERATION</b>	
Function off	
Function on	
BOB-duration	
<b>FUNCTION LV1</b>	

Duration	
Impulse	
Interval	
Two point	
Time:	
<b>FUNCTION LV2</b>	
Duration	
Impulse	
Interval	
Time:	
<b>HYSTERESIS LV1</b>	
Analysis (1,2,3)	
<b>HYSTERESIS LV2</b>	
Analysis (1,2,3)	
<b>ALARM/MESSAGE</b>	
Reagent low level	
Low water pressure	
Mf. analysis	
Ff. optics	
Ff. dosing fault	
Ff. dosing pump	
Ff. outlet to drain	
Mf. dirtiness	
power failure 24 V	
Mf. turbid	
Plant control	
Transfer error	
Meas. range exceeded	
Maint. int. exceeded	
<b>FUNCTION IN1</b>	
Normally open contact	
Normally closed contact	
<b>FUNCTION STOP</b>	
Normally open contact	
Normally closed contact	
<b>INTERFACES</b>	
Type 0-20 mA	
Type 4-20 mA	
Type RS232	
<b>FUNCTION AUX</b>	
Contact before analysis	
Contact during analysis	
Contact after analysis	
Time:	
<b>OPERATING TIME</b>	
<b>MAINTENANCE INTERV.</b>	
<b>CUSTOMER SERVICE</b>	



# Instrument settings

## Caution!

Your settings may be deleted if repairs are carried out. Therefore, note down your instrument settings in the table below before sending the instrument to our service team for repairs. Please enclose a copy of the table with the instrument. If you have noted down the settings, they can be easily re-entered by your service staff once any repairs have been completed.

Menu	Setting
<b>MODE OF OPERATION</b>	
Time-controlled	
Volume interval	
<b>DISPLAY UNIT</b>	
Display in °dH	
Display in °f	
Display in ppm CaCO <sub>3</sub>	
Display in mmol/l	
<b>TYPE OF REAGENT</b>	
500ml-bottle	
100ml-bottle	
TH2005 Water hard.	
TH2025 Water hard.	
TH2100 Water hard.	
TH2250 Water hard.	
<b>LIMIT VALUES</b>	
Limit val. 1:	
Limit val. 2:	
<b>FLUSH TIMES</b>	
Flush	
<b>TYPE OF WATER METER</b>	
1 Litre/Impulse	
2,5 Litres/Impulse	
5 Litres/Impulse	
10 Litres/Impulse	
100 Litres/Impulse	
500 Litres/Impulse	
1000 Litres/Impulse	
<b>BOB-OPERATION</b>	
Function off	
Function on	
<b>FUNCTION LV1</b>	
Duration	
Impulse	
Interval	
Two point	
Time:	
<b>FUNCTION LV2</b>	
Duration	
Impulse	
Interval	
Time:	
<b>HYSTERESIS LV1</b>	
Analysis (1,2,3)	
<b>HYSTERESIS LV2</b>	
Analysis (1,2,3)	
<b>FUNCTION STOP</b>	
Normally open contact	
Normally closed contact	

<b>INTERFACES</b>	
Type 0-20 mA	
Type 4-20 mA	
Type RS232	
<b>SPRACHE/LANGUAGE</b>	
DEUTSCH	
English	
Français	
Italiano	
Polski	
Nederlands	
Espanol	

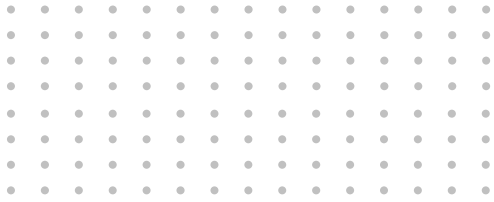

Gebrüder Heyl  
Analysentechnik GmbH & Co. KG  
Orleansstraße 75b  
D 31135 Hildesheim  
[www.hey1.de](http://www.hey1.de)



Scan the code and  
visit us on our website!

These operating instructions are the copyrighted property of Heyl Analysentechnik GmbH & Co. KG.

Technical changes:

Technical details subject to change due to continuous product development.

Version dated 28.01.2021

© Heyl Analysentechnik GmbH & Co. KG, Hildesheim

All rights reserved